

# Electric Door Strike with Vertical Adjustment

## SD-996C-NUVQ

12/24 VDC, Fail-Safe or Fail-Secure, UL Listed

The SECO-LARM SD-996C-NUVQ Electric Door Strike with Vertical Adjustment is compatible with a wide range of lock types including cylindrical, mortise, and mortise exit devices and can be configured for use in wood, aluminum, or metal doors. Included are various ANSI-sized faceplates that can be easily installed on the strike to match the door lock type and the strike is easily field-configurable for fail-safe or fail-secure applications.

### Features:

- UL 294 and UL 1034 Listed
- 12/24 VDC Operation
- Vertical adjustable deadbolt opening, sliding shim keeper, and deadlatch ramp accommodates a wide range of locks
- Accommodates deadbolts up to 1"
- Field selectable for fail-safe or fail-secure
- Includes 5 different stainless-steel faceplates
- Includes trim plate to hide gaps in installation
- Reversible non-handed design
- Static strength – 1,000-lb (4448N)
- Dynamic strength – 33ft-lb (45J)
- Tested to 250,000 cycles (UL Tested)
- Low current draw: 300mA@12VDC & 150mA@24VDC

### Specifications:

Operating voltage	12/24 VDC	
Current draw	12VDC	300mA
	24VDC	150mA
Static strength	1,000-lb (4448N)	
Dynamic strength	33ft-lb (45J)	
Endurance	250,000 cycles (UL Tested), Level IV	
Destructive attack	Level I	
Line security	Level I	
Standby power	Level I	
Latch throw	1" (25mm) max with 1/8" (3mm) door gap	
Operating temperature	14°~113° F (-10°~45° C)	
Operating humidity	0~85%	
Dimensions	1 5/8"x3 5/16"x1 13/16" (42x84x47 mm)	

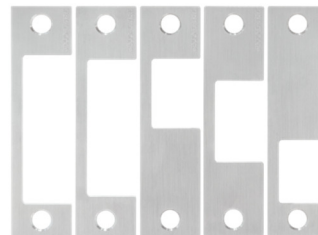
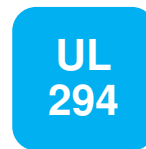

Five Faceplates Included (see back for details)

### Dimensions:

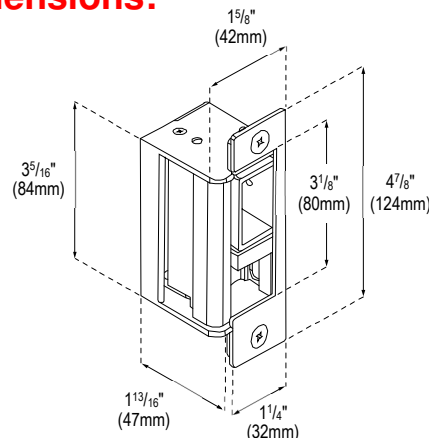

### SECO-LARM® U.S.A., Inc.

16842 Millikan Avenue, Irvine, CA 92606

Phone: (949) 261-2999 | (800) 662-0800 Fax: (949) 261-7326

Website: www.seco-larm.com Email: sales@seco-larm.com



Copyright © 2020 SECO-LARM U.S.A., Inc. All rights reserved. The SECO-LARM policy is one of continual development. For that reason, SECO-LARM reserves the right to change prices and specifications without notice. SECO-LARM is not responsible for misprints.

SECO-LARM® ENFORCER® CRIMEBUSTER® CBA SLI®

PI\_SD-996C-NUVQ\_200203.docx

### Faceplates:

**SD-996SS-11D1Q**

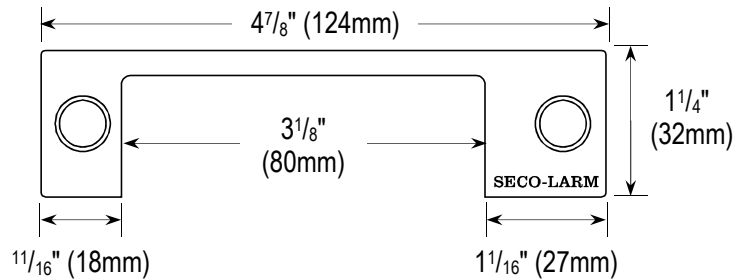
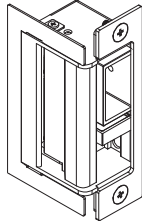

**SD-996SS-11D2Q**

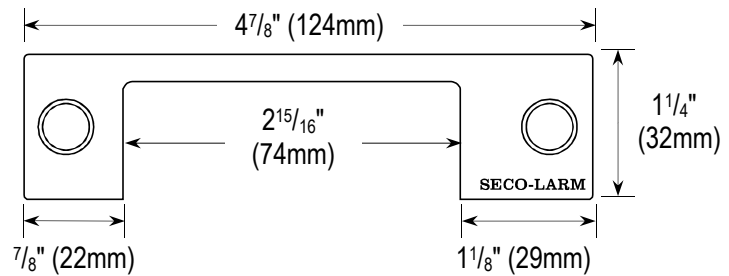
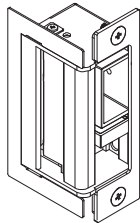

**SD-996SS-11L1Q**

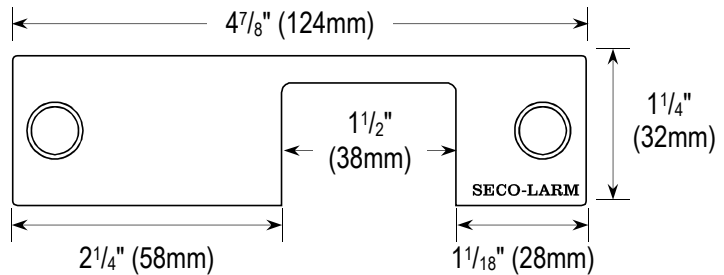
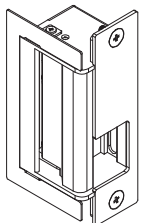

**SD-996SS-11L2Q**

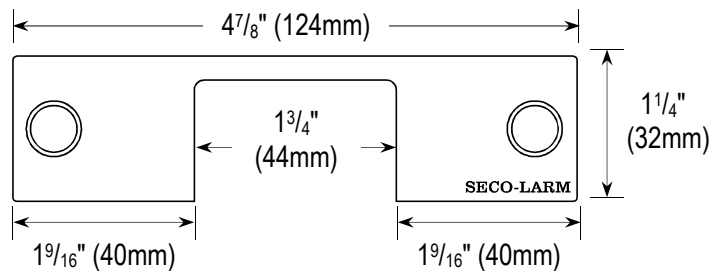
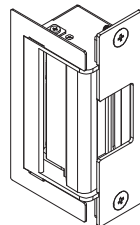

**SD-996SS-11L3Q**

