

# STB-3/8 TC

## RECESSED CONTACTS

.37"(9.5mm) Recessed Type W/Terminal Quick-Connect

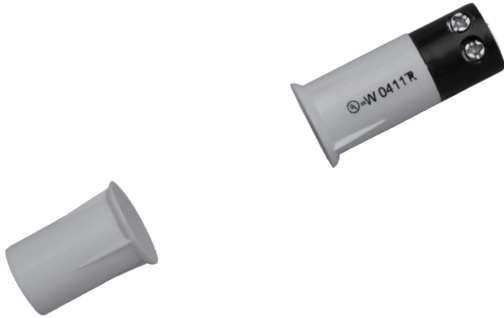

Contact Size: .37"×.92"(9.5mm×23.3mm)

Standard Magnet Size: .37"×.58"(9.5mm×14.8mm)



Standard Gap: .6"(15mm)

Colors: White, Brown



STB-3/8 TC: Terminal Connect, No Leads.

### Specifications

Part Number	Gap Inch(mm)	Loop Open/Closed	Reed Form	Max. Contact Rating (W)	Max. Initial Contact Resistance (mΩ)	Max. Switching Voltage (V)	Max. Switching Current (A)
STB-3/8 TC	.6"(15)	CLOSED	Normally Open	10	100	AC110/DC100	0.5
STB-3/8 TC WG	1"(25)	CLOSED	Normally Open	10	100	AC110/DC100	0.5
STB-3/8 TC DM	.5"(12.5)	CLOSED	Normally Open	10	100	AC110/DC100	0.5
STB-3/8 TC FLAT	.5"(12.5)	CLOSED	Normally Open	10	100	AC110/DC100	0.5
STB-3/8B TC	.5"(12.5)	OPEN	Normally Closed	10	100	AC110/DC100	0.5

OPERATING TEMPERATURE:-40°C to +60°C

### Outline Dimensions

Unit: inch(mm)

#### STB-3/8 TC

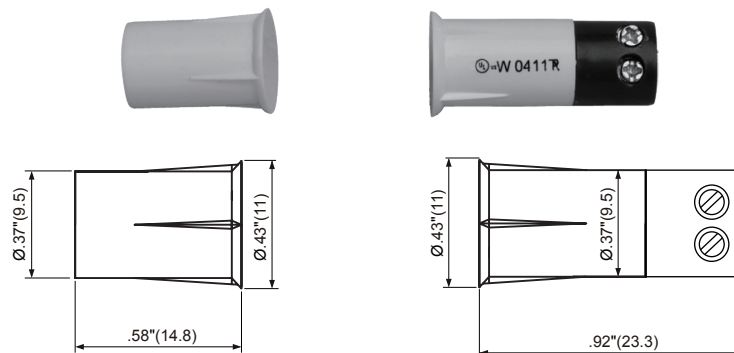

*"We Contact The World!"*<sup>®</sup>

The Best Product Guarantee Since 1984<sup>®</sup>  
**TANE ALARM PRODUCTS**

# STB-3/8 TC

## RECESSED CONTACTS

### Outline Dimensions

Unit: inch(mm)

#### STB-3/8 TC WG



Bare Rare Earth  
(BT 3/8"×3/4")

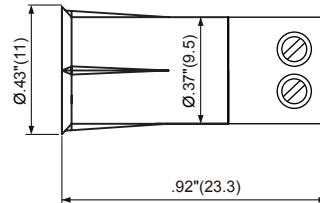

#### STB-3/8 TC DM



Bare Rare Earth  
(BT 3/8"×1/8"DM)

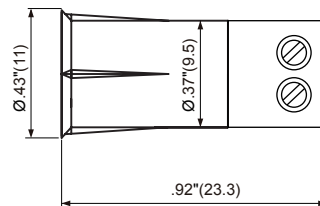
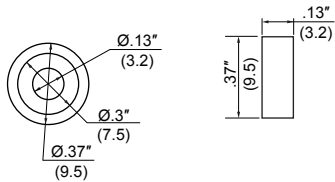

#### STB-3/8 TC FLAT



Bare Rare Earth  
(BT 1/8"×1/4"×1"ADH)

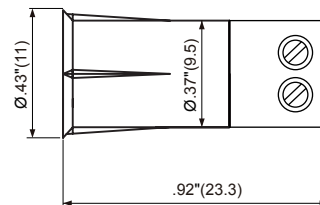
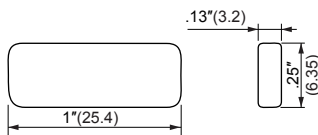

  
"We Contact The World"®

The Best Product Guarantee Since 1984 ®  
**TANE ALARM PRODUCTS**